

COOL

DISPLAY SOLUTIONS INC.

USER MANUAL

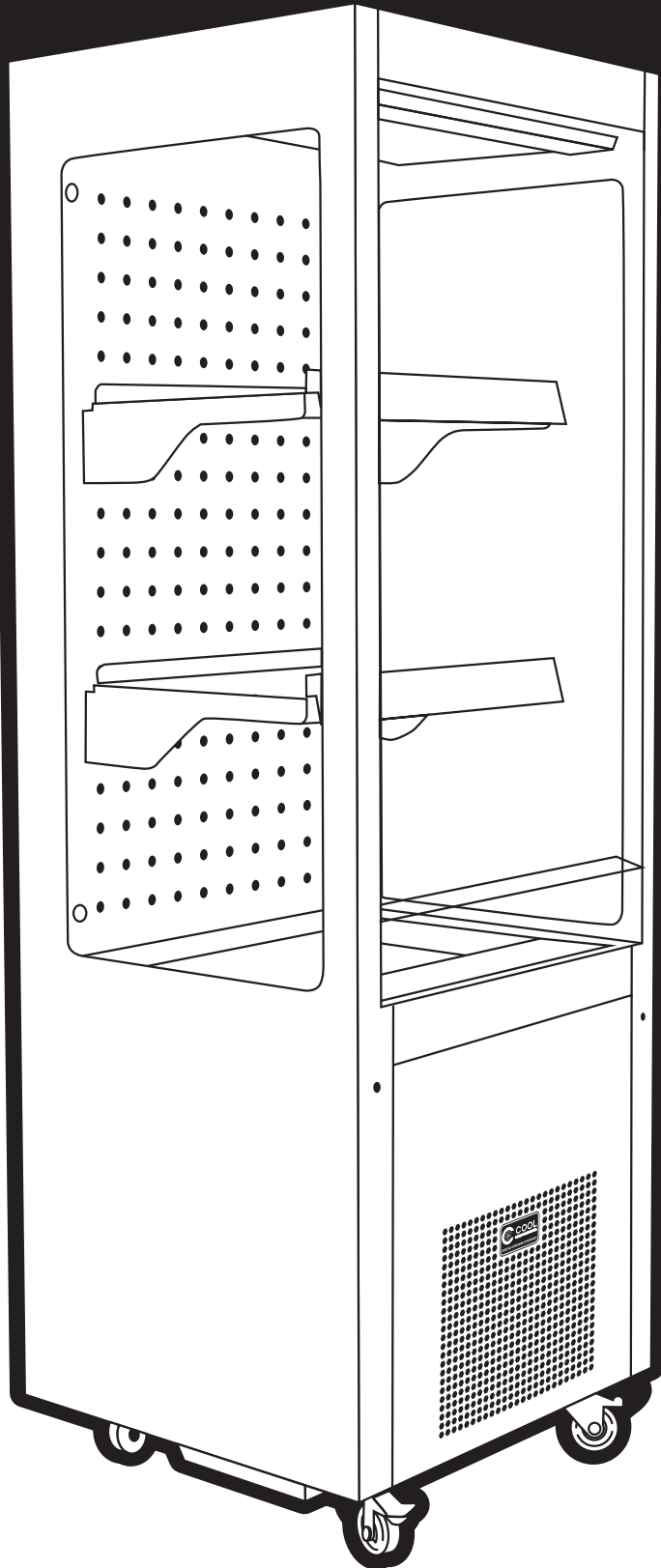

AVO

55G Series

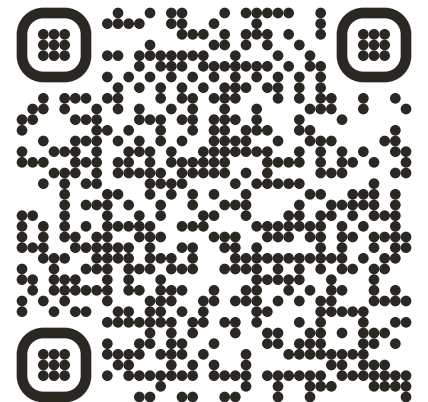

Congratulations on the purchase of your new Cool Display Solutions premium product!

At Cool Display Solutions, we develop products with complete devotion to quality and ease of use. That's our passion. To obtain the best results, we advise you to read this user manual* carefully. Even though this product has been designed according to the highest standards, it is important to use and maintain your appliance correctly.

A handwritten signature in white ink on a black background. The signature is stylized and cursive, appearing to read 'Bob Jones'.

Bob Jones
CEO and Founder, Cool Display Solutions

*Cool Display Solutions constantly works on the further development of all models. Therefore please understand that we have to reserve the right to make design, equipment and technical modifications.

Table of Contents

- 1.) SAFETY INSTRUCTIONS..... 4
- 2.) PUTTING INTO OPERATION..... 7
- 3.) USE OF THE APPLIANCE.....8
- 4.) CLEANING AND MAINTENANCE..... 10
- 5.) TECHNICAL SPECIFICATIONS.....11
- 6.) TROUBLESHOOTING.....12
- 7.) TAKING THE UNIT OUT OF SERVICE.....15
- 8.) ENVIRONMENTAL POLICY & RECYCLING.....15
- 9.) DISPOSING OF THE APPLIANCE.....15
- 10.) WARRANTY STATEMENT.....16

1.0 Safety Instructions

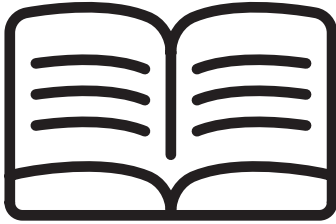

Please read this operating and maintenance manual carefully. We suggest to keep the guide in your possession during the entire life cycle of the product.



After delivery, immediately check the appliance for possible transport damage and make sure it works properly. All safety devices must be present and functional before operating the appliance.

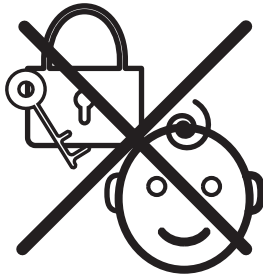

Do not leave children without supervision. Ensure that they do not play with the appliance. In the case of appliances provided with locks, the key must be kept at a site where children cannot have access to it to avoid unintentional locking.

Installation and Use

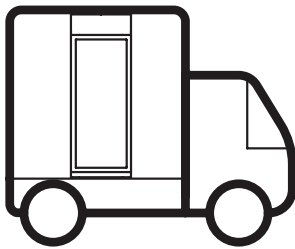

The appliance always has to be transported and displayed vertically.

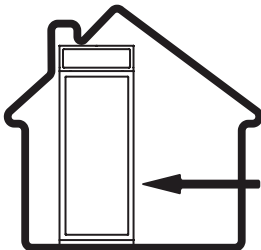

The appliance is designed for inside use only.

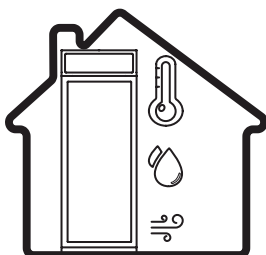

The surroundings should not transcend the following conditions (based on a standard environment):

- **25°C / 77°F temperature**
- **60% humidity**
- **0,2 m/s air speed**

1.0 Safety Instructions

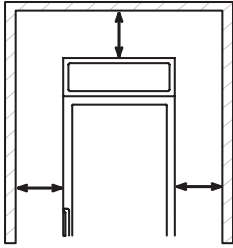

Keep a minimum distance of 10 cm/3.9 inches between the appliance and neighbouring surfaces (walls, roof, furniture etc.).

Keep clear of obstructions all ventilation openings in the appliance enclosure or for built-in structure.

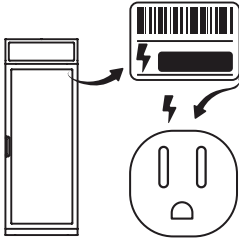

Before connecting the device, check:

- ***The power rating (on the type plate)***
- ***The relevant local electrical safety regulations***

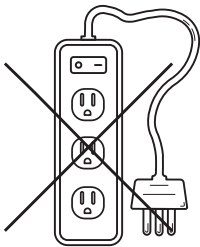

Do not use an extension cord to connect the appliance to the electrical circuit.

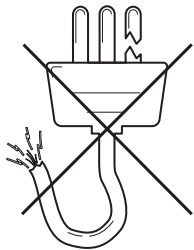

Make sure that power cable and plug are undamaged before connecting the appliance. The damaged cable can only be replaced with a cable identical to the original part.

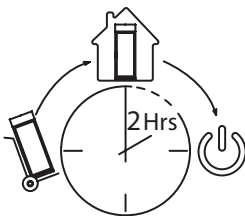

After delivery, keep the appliance in a warm ambient temperature for 2 hours before starting it.

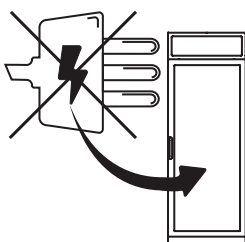

Do not use electrical appliances inside the storage compartments of the appliance, unless they are of the type recommended by the manufacturer.

1.0 Safety Instructions



Do not store explosive substances such as aerosol cans with a flammable propellant in the appliance. The user is solely responsible for damages to properties or products, or injuries to persons resulting from careless and improper use of the appliance.

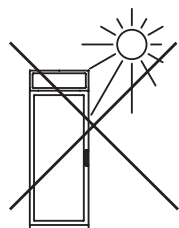

Do not expose the appliance into direct sunlight. Do not heat the appliance to more than 70°C/158°F.

1.2 Defects



Only authorised service specialists may perform work on the electrical and refrigeration systems. If this is not observed, all warranty and liability claims become invalid.

Damaging the refrigerant circuit can lead to severe injuries. Do not damage the refrigerant circuit!



Make sure that the appliance is thoroughly cleaned and dried. Proper cleaning prevents corrosion and mould formation.

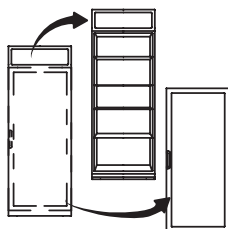

Appliances out of use may be dangerous for children, therefore position the appliance in such manner that no person can get locked up.

1.3 When Not In Use

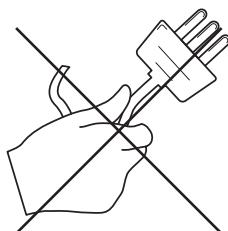

When disconnecting the appliance from the power supply, always take hold of the plug. Do not pull the cable.

2.0 Putting Into Operation

2.1. Installation

IMPORTANT!

Never move the appliance by grasping the sides.

Position the device where it is protected from sunlight and other heat sources, since operation may be disturbed if the ambient temperature exceeds +25°C/77°F.

The appliance should not be operated in rooms where the temperature drops below +10°C/50°F since this disrupts the lubrication of the compress

Leave at least 10 cm/3.9 inches space between the appliance's side walls/roof/back and neighbouring surfaces such as other devices, walls, furniture and ceiling to provide free air flow behind the device to enable proper operation.

If the furnishing of the room allows positioning only close to the heat source the following minimum clearances must be kept: or.

- *Put a 0.5-1cm/0.393 inches thick insulation board between two devices if they are 3 cm/1.18 inches or less apart.*
- *Min. 30 cm/11.8 inches from oil or coal-fired ovens.*

WARNING!

Keep all ventilation openings in the appliance clear of obstructions.

2.2. Electrical Connection

The appliance may be connected to 110 V mains via properly mounted grounded socket. Check if the voltage meets the local voltage and make sure that the connecting cable isn't stuck anywhere.

A fuse/circuit breaker of 10 A is required for the operation of the appliance.

If the connection cable is damaged or it has to be extended, the job must be done by a qualified electrician to avoid the dangerous situations.

Do not use an extension cord! The appliance must be positioned in a way that the main plug is easily accessible.

3.0 Use of the Appliance

3.1. Starting Up

IMPORTANT!

All packaging materials are recyclable.

1. Make sure that all packaging material and foreign objects are removed from the appliance.
2. Clean the appliance with detergent before switching it on, dry it with a soft, clean cloth and let it ventilate for a while.
3. It is advised to keep the appliance in an upright position for at least 2 hours after transport before using it.
4. It is advised to switch on the appliance and check its operation before positioning it at the final place.
5. See separate instructions for detailed guidelines on the promotional display appliance assembly. In case the instructions are missing, please contact the seller or your local service provider.
6. Place the shelves on the shelf holders.
7. It is advised to switch on the appliance and check its operation before positioning it at the final place. Connect the plug into the socket.
8. Leave the appliance connected in an empty state for 2 hours to check the functioning before adding goods for the first time. Do not load food to be chilled before the temperature display reads +6°C.
9. Apply brakes to prevent the appliance from moving.

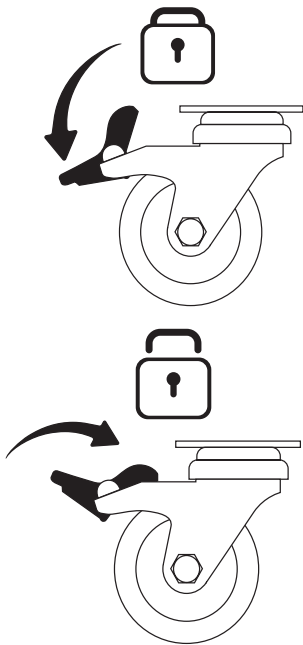

IMPORTANT!

Wear safety gloves during the installation.

3.2 Shelf Installation

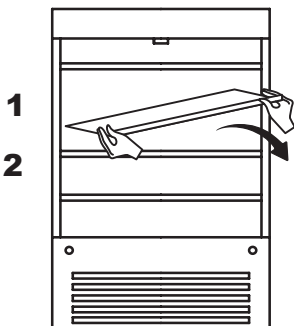

1. Attach shelf supports to shelf rails at the desired height.
2. Slide the shelf into the appliance and mount it on supports.
3. Make sure the shelf stays stable on its supports.

3.3 Filling

To achieve optimal cooling, it is advised to fill up the appliance when it is less frequently used.

1. **Check the maximum load.**
2. **Do not overload the device with products.**
3. **Be careful not to block air circulation.**

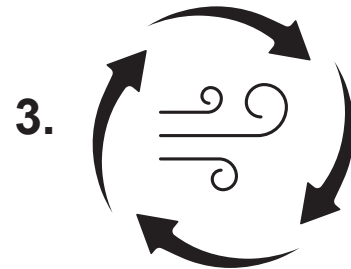
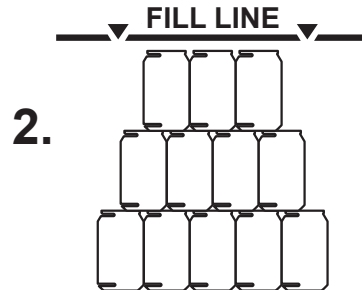
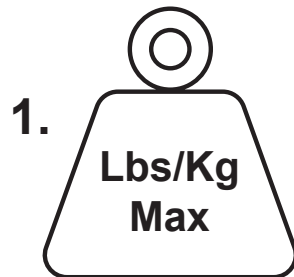

IMPORTANT!

Once the appliance is switched off, or in case the power is cut off, wait for at least 5 minutes before plugging in again to avoid damaging the compressor or cooling system of the appliance.

IMPORTANT!

Do not point spotlights at the unit.

3.4 Energy Saving Tips

Do not place the appliance in direct sunlight, HVAC outlets or near heat-producing appliances (like ovens, boilers and heaters). The appliance reaches its top efficiency when it works 24/7, do not switch it off during the night.

Keep your appliance clean and well maintained: dust on the condenser or any unsolved problem can cause increased energy consumption.

Fill the appliance according to the prescribed instructions to allow energy-efficient operation.

Wipe goods dry before placing them in the appliance. This cuts down on moisture build-up inside the appliance. Turn off the interior lighting of the appliance for the night. Maintain and clean the appliance in a proper way. If the condenser coil is not cleaned at least 2 times per year, the efficiency of the appliance will decrease significantly.

Use the ECO frame provided with ECO models to increase the efficiency of the appliance*.

HINT!

Do not place the appliance in direct sunlight, HVAC outlets or near heat-producing appliances (like ovens, boilers and heaters).

4.0 Cleaning & Maintenance

IMPORTANT!

Lack of maintenance will cause the appliance to break down.

4.1. Preparation

1. Remove or relocate appliance's contents.
2. Disconnect the appliance from the mains.
3. Let the appliance defrost for 12 hours.

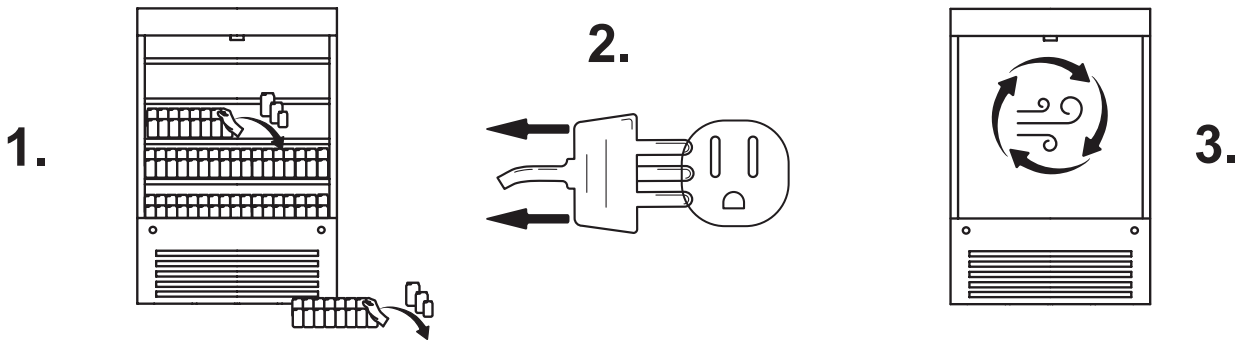

4.2. Clean Inside & Outside

IMPORTANT!

Do not clean the appliance with high-pressure or steam cleaners.

5. Remove shelves to reach all surfaces.
6. Clean the inside and outside of the appliance with water and non-aggressive detergent.
7. Dry previously cleaned surfaces with a soft, clean and dry cloth.

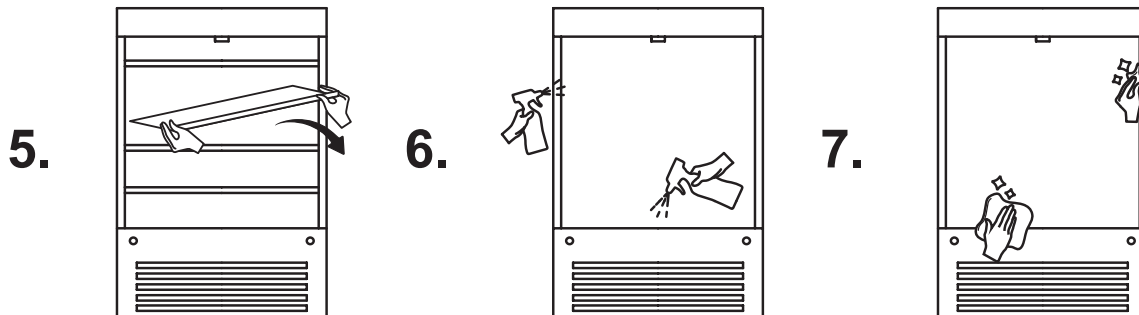

IMPORTANT!

Wear safety gloves to avoid the danger of injury during cleaning.

5.0 Technical Specifications

Overall Dimensions	17.5" x 19" x 55" 44.5 x 48.26 x 165.1cm
Weight	138 lbs / 62Kg (approximate)
Gross Volume	9.42 cubic ft. / 267L
Power Input (W)	110 V
Lighting	2 x Vertical LED Lighting
Compressor	Danfoss R290
Temperature	+2°C - +6°C / 35.6°F - 42.8°F
Defrosting	Automatic
Evaporator Type	Finned Coil
Condensor Type	Low Maintenance
Temperature Control	Electronic
Ambient	Maximum 22°C - 72°F / 60% Humidity
Shelving x 2 pieces	16.375" x 10.625" (adjustable) 417mm x 270mm
Bottom Layer	16.375" x 10.625" 417mm x 270mm

6.0 Troubleshooting

<i>Problem</i>	<i>Possible Causes</i>	<i>Solution</i>
The appliance does not operate.	The appliance is not switched ON.	Switch ON the appliance
	The power plug is not plugged in correctly	Reconnect the appliance to the power supply in a correct way
	Power relay tripped	Wait for at least 5 minutes then restart the appliance
	The power cable/plug is damaged	Contact the seller or your local service provider
	The airflow is restricted	Check the distance between the appliance and its surroundings /Nothing blocks the airflow inlets/outlets / Condenser is not dirty
	The fuse is blown/the circuit breaker tripped	Replace the fuse/reset the circuit breaker
	The digital controller may be defective	Contact the seller or your local service provider
Water condensation on surfaces	Too high ambient temperature and/or relative humidity %	Install the appliance in an adapted environment
Appliance gets too cold	Too low ambient temperature	Install the appliance in an adapted environment
	The temperature regulation may be incorrect	Contact the seller or your local service provider
LED lights do not operate	The appliance is not switched ON	Switch ON the appliance
	Lights are turned OFF	Switch ON lights using the digital controller
	LED lights are burned out	Contact the seller or your local service provider

6.0 Troubleshooting

Problem	Possible Causes	Solution
Unpleasant smell	Re-evaporation tray is dirty.	Contact the seller or your local service provider
Appliance's performance level of cooling is not enough	Too high ambient temperature and/or relative humidity %	Install the appliance in an adapted environment
	The airflow is restricted	Check the distance between the appliance and its surroundings /Nothing blocks the airflow inlets/outlets / Condenser is not dirty
	A large number of goods inserted	Fill the appliance according to instructions
	Wrong temperature setting	Check settings using digital controller
	The cooling system may be defective	Contact the seller or your local service provider
Disturbing noise/ Disturbing vibration	The gurgling sound is produced by the flow of refrigerant	Such sound is normal
	Popping and cracking sounds are produced by the contraction and expansion of refrigerant	Such sounds are normal
	The surface under the appliance is not flat enough	Position the appliance steadily on a flat surface
	The appliance is not levelled correctly	Level the appliance to ensure that its position is steady
The digital controller does not operate	The appliance is turned OFF	Switch ON the appliance
	The electronic board may be defective	Contact the seller or your local service provider

6.0 Troubleshooting

<i>Problem</i>	<i>Possible Causes</i>	<i>Solution</i>
Excessive ice formation in the evaporator area	Too high ambient temperature and/or relative humidity %	Install the appliance in an adapted environment

In case the malfunction is not caused by any of the above-mentioned factors or persists over a long period of time or in order to order spare parts, please contact the seller, your local service partner or get in touch with our after-sales service: **1.866.864.5273** | info@cooldisplaysolutions.com*

**The minimum period during which spare parts, necessary for the repair of the appliance is 8 years after placing the last unit of the model on the market.*

7.0 Taking the Appliance Out of Service

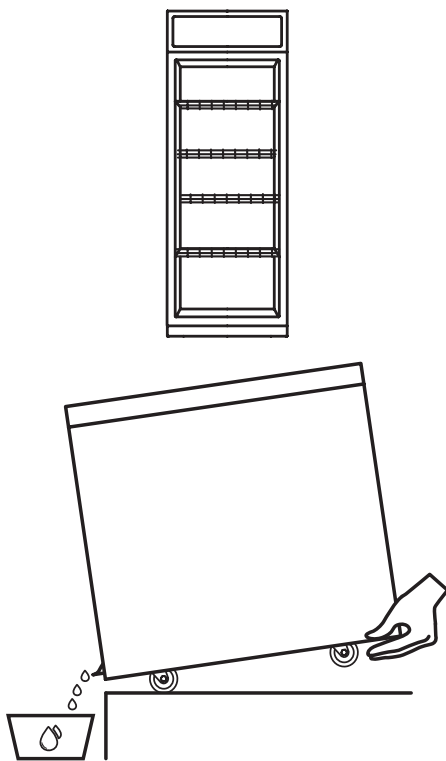

Empty the appliance's contents and pull out the power plug.

Empty the appliance's contents and pull out the power plug. Remove the corrugate sleeve if present.

Release the brakes. Empty the appliance to the floor drain or a water container by gently tilting the appliance backwards.

Make sure that the appliance is thoroughly cleaned and dried. Thus mould formation and corrosion are prevented.

The appliance out of use may be dangerous for children, therefore position the appliance in such manner that no person can get locked up.

IMPORTANT!

Secure loose parts and empty the drain of the appliance before moving it into storage.

8.0 Environmental Policy & Recycling

Environmental awareness is key throughout the complete life cycle of our products: from designing to producing it to finally recycling it.

We keep a close eye on the economical and effective use of new environmentally friendly materials in our products and production. Our target is to minimise the use of non-renewable natural resources.

We are convinced that sustainable production is the only correct way of working with respect for our customers, consumers and our planet today and in the future.

We strongly advise you to visit www.cooldisplaysolutions.com to check the optimal storing temperatures for food and beverages. Incorrect temperature setting may result in spoilage and food waste.

9.0 Disposing of The Appliance

WARNING!

Thermal insulation material is EPP.

The appliance contains some reusable materials and should be disposed of properly — not simply with unsorted household refuse. Appliances which are no longer needed must be disposed of in a professional and appropriate way, in accordance with the current local regulations and laws.

Please check your obligations in accordance with the national WEEE* provisions and the local WEEE disposal partner. Ensure that the piping is not damaged in the process.

Both insulating material and the coolant of the appliance bought by you are environment-friendly materials, which do not damage the ozone layer around the globe in any form.

**Waste Electrical and Electronic Equipment Directive*

The warranty terminates upon:**

- outside & wrong usage
- not following the instructions
- negligence of maintenance

***The minimum duration of the warranty is 12 months. For more information, please contact the seller, your local service partner or get in touch with our after-sales service: **1.866.864.5273** | info@cooldisplaysolutions.com*

Cool Display Solutions Inc. Refrigeration Unit Warranty Statement

Limited 30 Day Cosmetic Warranty

Lights and printed sleeves are warranted to be free from defective materials and workmanship for a period of thirty (30) days from the date of purchase. Any defects must be reported to the Cool Display Solutions sales representative within seven (7) days from the date of installation of the unit. This limited warranty excludes any type of freight/concealed damage.

1 Year Parts & Labour Warranty

Cool Display Solutions warrants to the original purchaser of every new refrigeration unit, the cabinet and all parts thereof, to be free from defects in material and workmanship under normal and proper use and maintenance as specified by Cool Display Solutions and upon proper installation and start-up in accordance with the instruction packet supplied with each refrigeration unit. Cool Display Solution's obligation under this warranty is limited to a period of one (1) year from the date of original installation or 14 months after shipment date from Cool Display Solutions, whichever comes first.

Terms Applicable to Each Warranty

Any part covered under the above warranties that is determined by Cool Display Solutions to have been defective within the time frame is limited to the repair or replacement of the unit, including labour charges of defective parts or assemblies. The warranty shall include freight charges for all parts and/or replacement units providing that the Cool Display Solutions specially designed shipper and instructions are adhered to.

Warranty Claims

All claims for labour or parts must be made directly through Cool Display Solutions. All claims must include: serial number of refrigeration unit, date of installation and all pertinent information relating to the alleged defect. A warranty claim is subject to denial if the failed unit is not returned per the explicit freight instructions provided by Cool Display Solutions.

What is not covered by this Warranty

Cool Display Solutions sole obligation under this warranty is limited to either the repair or replacement of parts, subject to the additional limitations below.

The warranty does not cover issues caused by improper installation or lack of basic preventative maintenance which includes regular cleaning of the unit.

No Consequential Damages

Cool Display Solutions is not responsible for economic loss, profit loss or losses arising from food or product spoilage claims whether or not on account of refrigeration failure.